

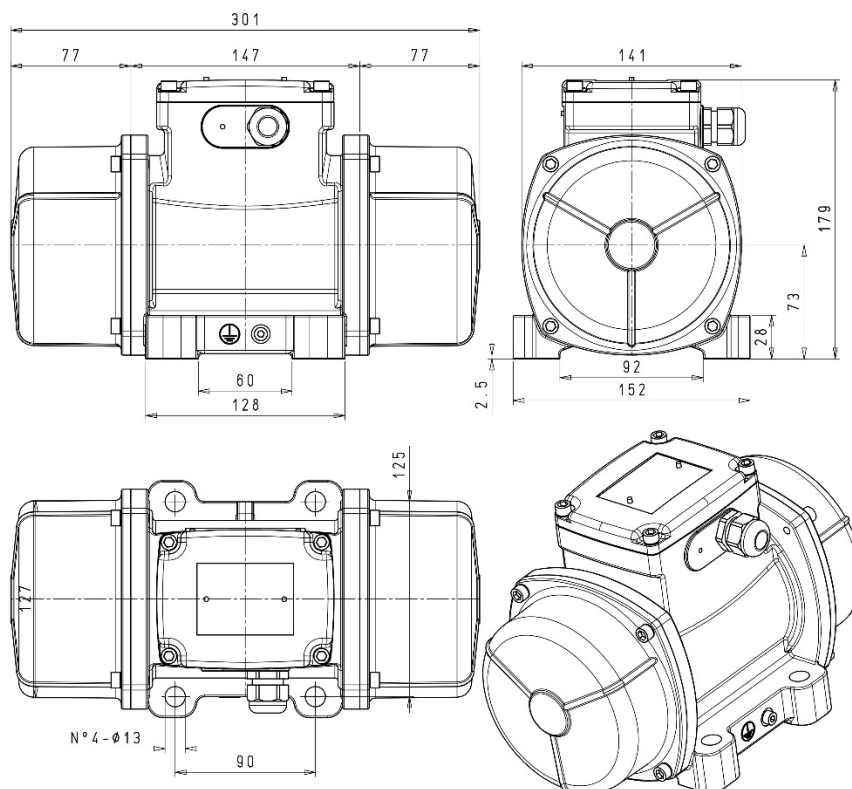

TRILMOTOR – VIBRATOR ONBALANSMOTOR

Type : MVS1 15/200-S02 - 4 Polig

Arbeidsmoment	16,84	KgCm
Centrifugaal kracht	2,08	KN
Toerental	1500	t.p.m.
Frequentie	50	Hz.
Ingangsvermogen	170	W.
Voedingsspanning	230/400	V.
Stroom	0,71 / 0.41	A.
Power Factor	0.63	(Cos Phi)
Rendement	55	%
Aanloopstroom	1,61 / 0,96	A.
Start tijd	1,05	Sec.
Omgevingstemperatuur	40	°C
Lager Type	6304 2ZR C3	
B10-waarde Lager	23400	
IP	66	
Gewicht	12,5	Kg.



II2D – Temp. 120°C